

“Phenomenon combina piccoli materiali producendo profondità e vastità. Le diverse espressioni di Phenomenon, quali nidi d’ape, cristalli di neve, formazioni di ghiaccio e cellule vegetali, evocano nella memoria scenari naturali”.

“Phenomenon combines small materials, creating depth and breadth. The different expressions of Phenomenon, such as honeycombs, snowflakes, ice formations and plant cells, evoke memories of natural scenes.”

Tokujiin Yoshioka

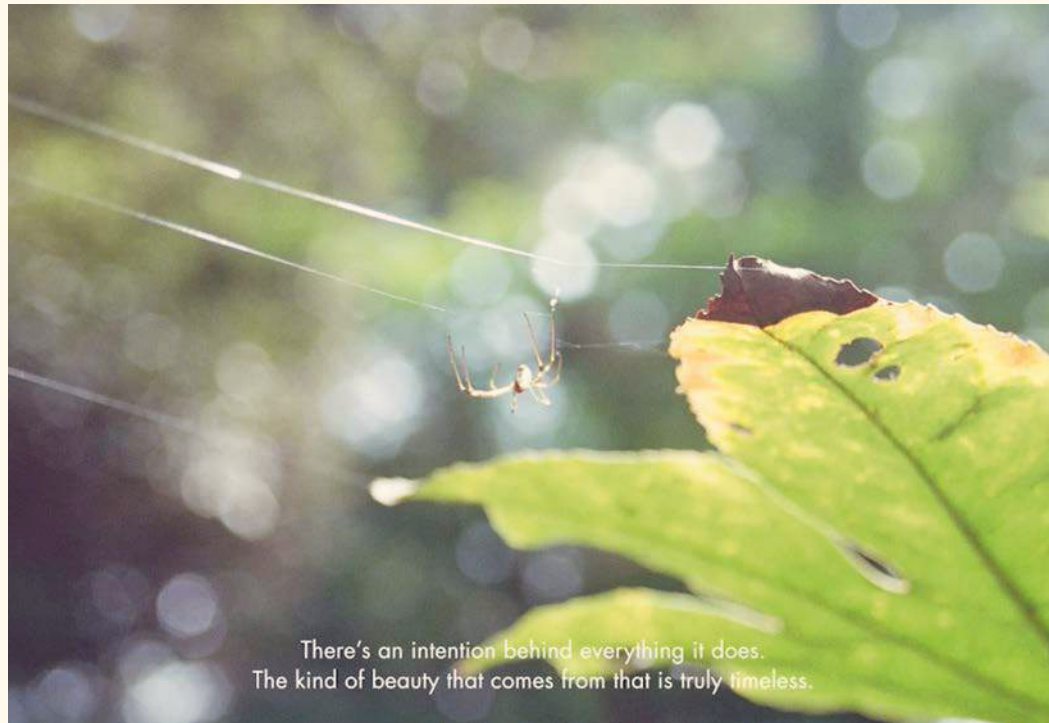



There's an intention behind everything it does.
The kind of beauty that comes from that is truly timeless.



Adding in my own memories of nature experienced
up to this point, I want to make something universal.

Phenomenon

Tokujiin Yoshioka

Phenomenon è un progetto ceramico capace di esprimere con originalità le texture derivate dalla natura, non per imitarne l'aspetto ma per evocarne l'emozione. La collezione integra nella materia ceramica sostanze quasi microscopiche e produce un effetto visivo di profondità e ampiezza sulla superficie. Ricorda diverse espressioni di pattern naturali come il favo delle api, i cristalli di neve, i candelotti di ghiaccio, le cellule delle piante ed evoca memorie di scenari naturali e di esperienze individuali del mondo della natura.

In occasione della nuova edizione, Phenomenon si arricchisce con 3 nuovi colori – Blu, Rosa e Verde – che si aggiungono ai 4 colori storici – Bianco, Grigio, Fango e Nero –, ognuno dei quali viene declinato su tutti gli elementi disponibili: Honeycomb A, Honeycomb B, Rock, Air, Wind, Rain A, Rain B e Rain C.

Il particolare effetto "polveroso" è stato ottenuto combinando impasti colorati a umido e colorazione a secco. Questo procedimento ha permesso di avere un prodotto in grès porcellanato non smaltato a tutta massa, caratterizzato

da un effetto particolarmente materico e naturale. Inoltre, l'utilizzo di miscele personalizzate ha consentito di ottenere colori unici e originali.

Phenomenon viene prodotta con metodo artigianale: ogni elemento viene pressato nella più piccola dimensione possibile e lavorato con precisione per creare un mix di tecnica e innovazione, garanzia di altissima qualità.

Alla gamma si aggiungono anche i nuovi Phenomenon Glossy: i formati Honeycomb B, Rock e Rain A sono stati scelti per sperimentare la finitura smaltata per la prima volta, declinata nei colori Bianco, Nero, Oro e Argento. Le dimensioni estremamente ridotte delle tessere hanno reso necessario implementare un nuovo processo produttivo, che accosta il lavoro industriale a quello artigianale con l'obiettivo di fare risaltare al massimo la finitura: tutta la realizzazione è manuale e il processo produttivo è stato ripensato appositamente. Gli smalti applicati enfatizzano al massimo il gioco di luci e ombre, già presente nella versione non smaltata.

Phenomenon is a ceramic project able to express textures deriving from nature in an original way, not simply to reproduce their look but to evoke an emotion. The collection integrates almost microscopic substances into the ceramic material, creating a visual effect of depth and breadth on the surface. The collection makes references to different expressions of natural patterns such as honeycombs, snowflakes, needle ice, plant cells, evoking memories of natural scenes and individual experiences of the natural world.

On the occasion of the new edition, Phenomenon is enriched with 3 new colours – Blu, Rosa and Verde – which join the 4 historical ones – Bianco, Grigio, Fango and Nero –, each of which is offered on all the available elements: Honeycomb A, Honeycomb B, Rock, Air, Wind, Rain A, Rain B and Rain C.

The distinctive "powdery" effect is obtained by combining coloured bodies and dry colouring. This process makes it possible to develop a product in unglazed full-body porcelain stoneware which is characterised by a particular natural and tactile look and feel. In addition, the use

of personalised mixtures allows for the creation of unique and original shades.

Phenomenon is a craft product: each element is pressed in the smallest possible size and precisely refined by hand to create a mix of technique and innovation, guaranteeing the highest quality.

The range also includes the new Phenomenon Glossy: the Honeycomb B, Rock and Rain A modules have been chosen to experiment the glossy finish for the first time, featuring the Bianco, Nero, Oro and Argento shades. The extremely small size of the tesserae has made it necessary to set up a new production process that combines industrial and craft approaches with the objective of making the finish stand out as much as possible: production is entirely by hand and the manufacturing process has been specially redesigned. The applied glazes bring out the effects of light and shadow, already present in the non-glazed version.

Mosaics

Phenomenon è espressione dell'abilità di esperti maestri artigiani italiani, che pressano singolarmente e lavorano con precisione ciascun pezzo. Con le loro piccole dimensioni, gli elementi di collezione ricordano i tasselli di un mosaico contemporaneo.

Phenomenon is the expression of the finest Italian craftsmanship: each element is pressed and refined individually by expert hands. With their small formats, the modules resemble pieces of a contemporary mosaic.



Models

Il range di collezione è composto da 8 elementi che, con le loro forme, richiamano texture appartenenti al mondo naturale come nidi d'ape, formazioni di ghiaccio e cellule vegetali.

The collection range features 8 elements that, thanks to their silhouettes, recall textures from the natural world such as honeycombs, ice formations and plant cells.

Rain A

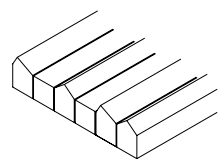

Rain B

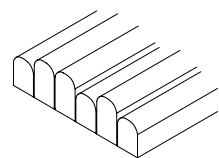

Rain C

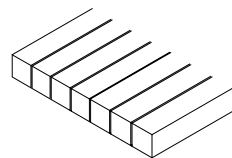

Rock

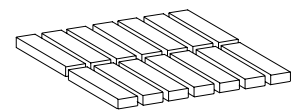

Honeycomb A

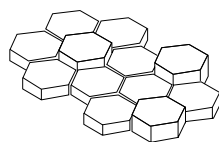

Honeycomb B

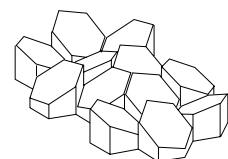

Air

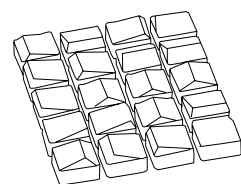

Wind

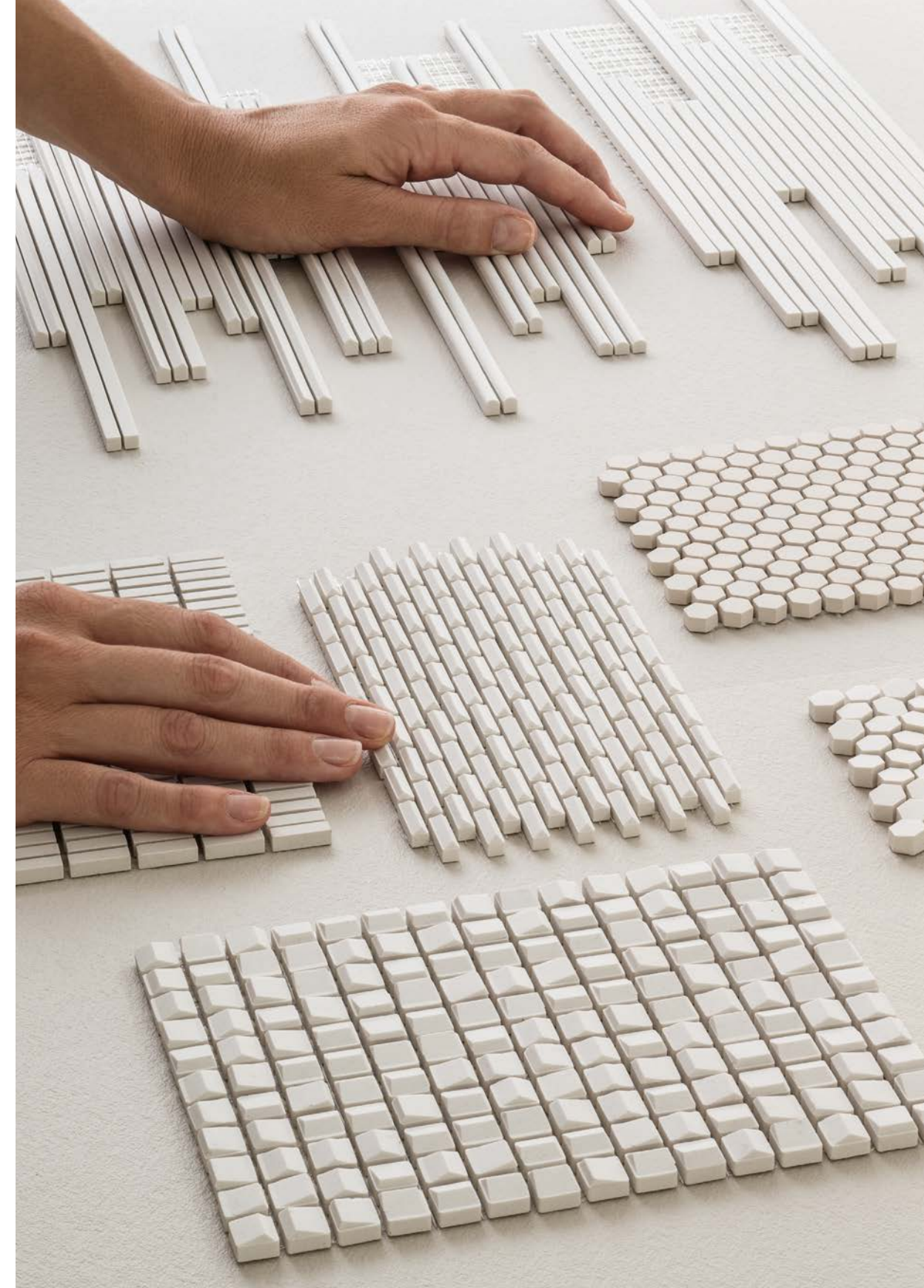
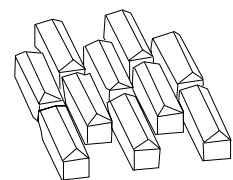

Colours

Phenomenon propone una palette di 7 colori matt dall'effetto "polveroso", unici e originali, sviluppati mediante l'utilizzo di miscele personalizzate.

Phenomenon provides a colour palette of 7 matt shades with a "prudery" effect, unique and original, created with personalised mixtures.

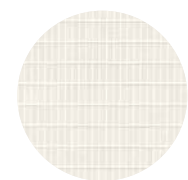

Bianco

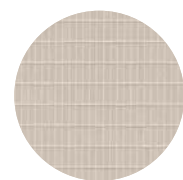

Grigio

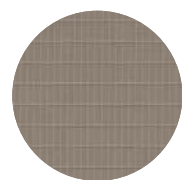

Fango

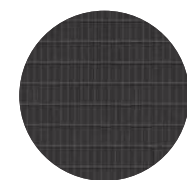

Nero

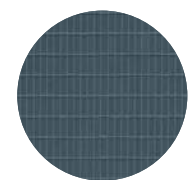

Blu

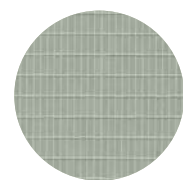

Verde

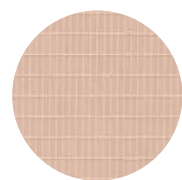

Rosa

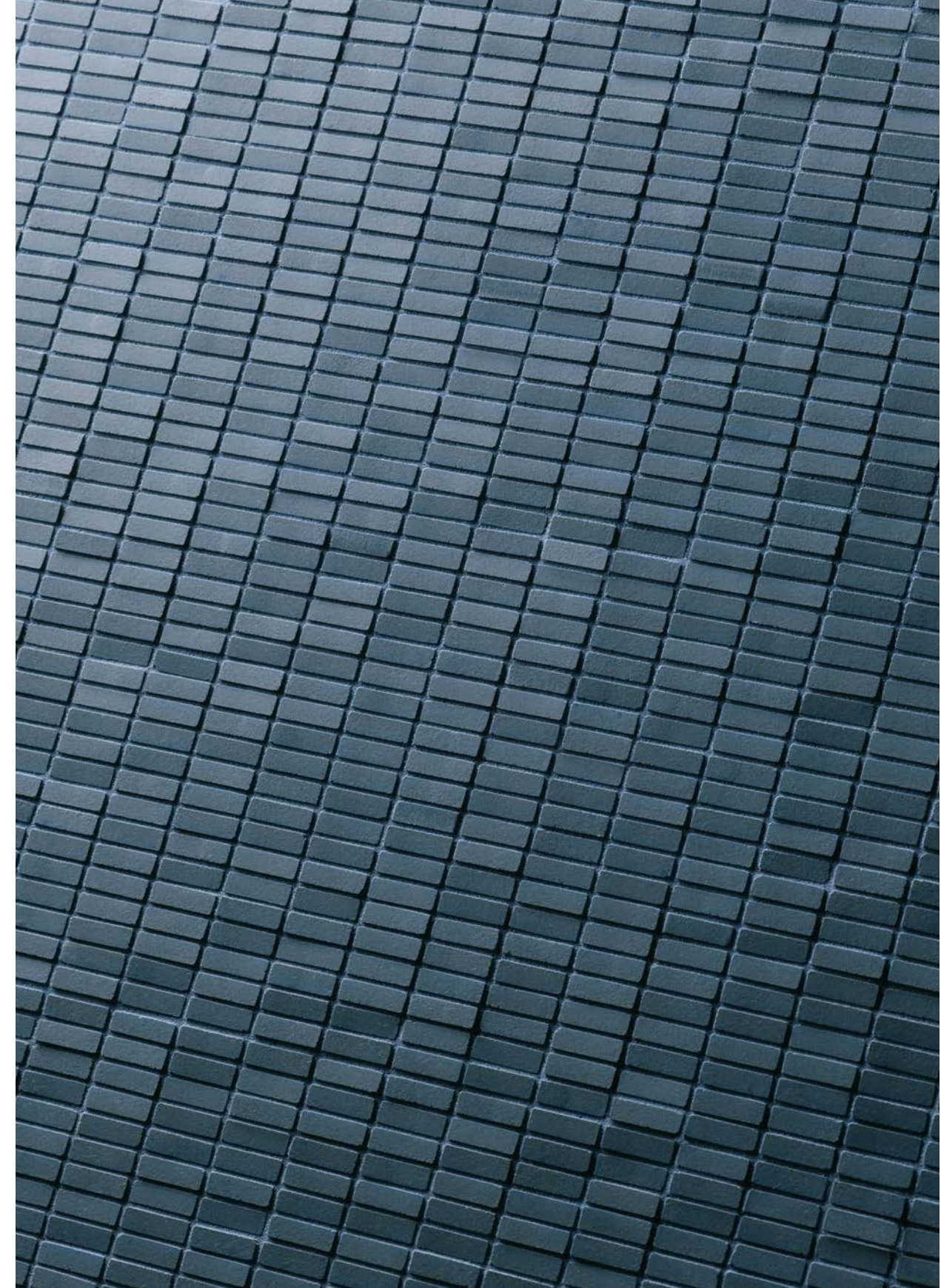

Glossy

I colori opachi sono affiancati da 4 colorazioni con finitura lucida, che enfatizzano al massimo i giochi di luci e ombre presenti sulla superficie. Phenomenon Glossy è disponibile nei modelli Rain A, Honeycomb B e Rock.

The matt shades are joined by 4 colours with glossy finish, that enhance the plays of light and shadow taking place on the surface to the maximum. Phenomenon Glossy is available in the Rain A, Honeycomb B and Rock modules.

Rain A

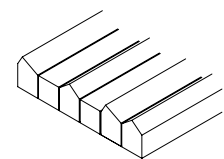

Honeycomb B

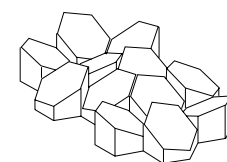

Rock

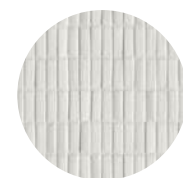
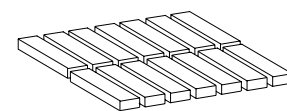

Bianco Glossy



Nero Glossy



Oro

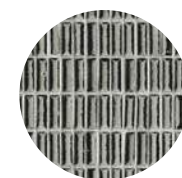

Argento

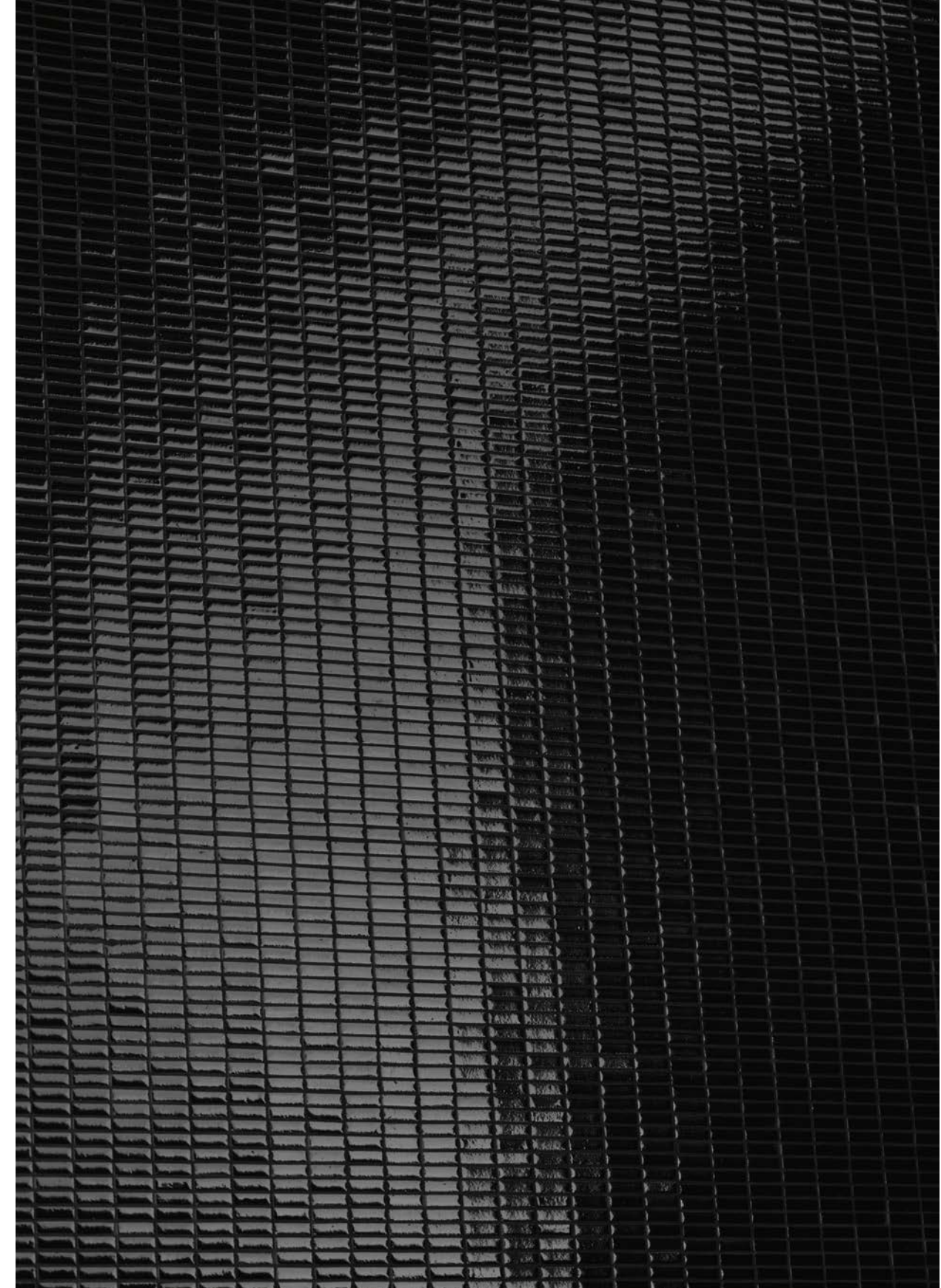

Phenomenon

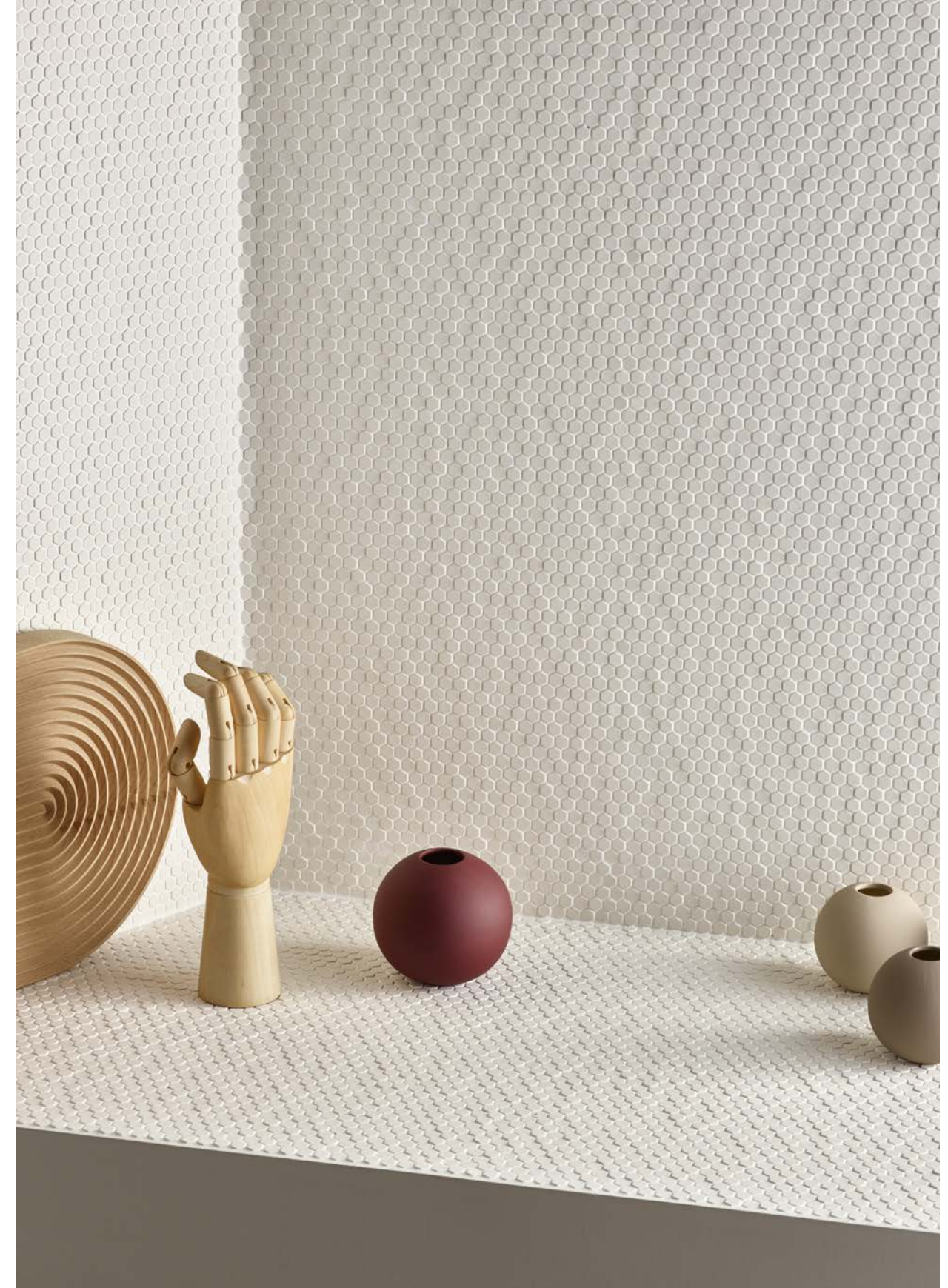

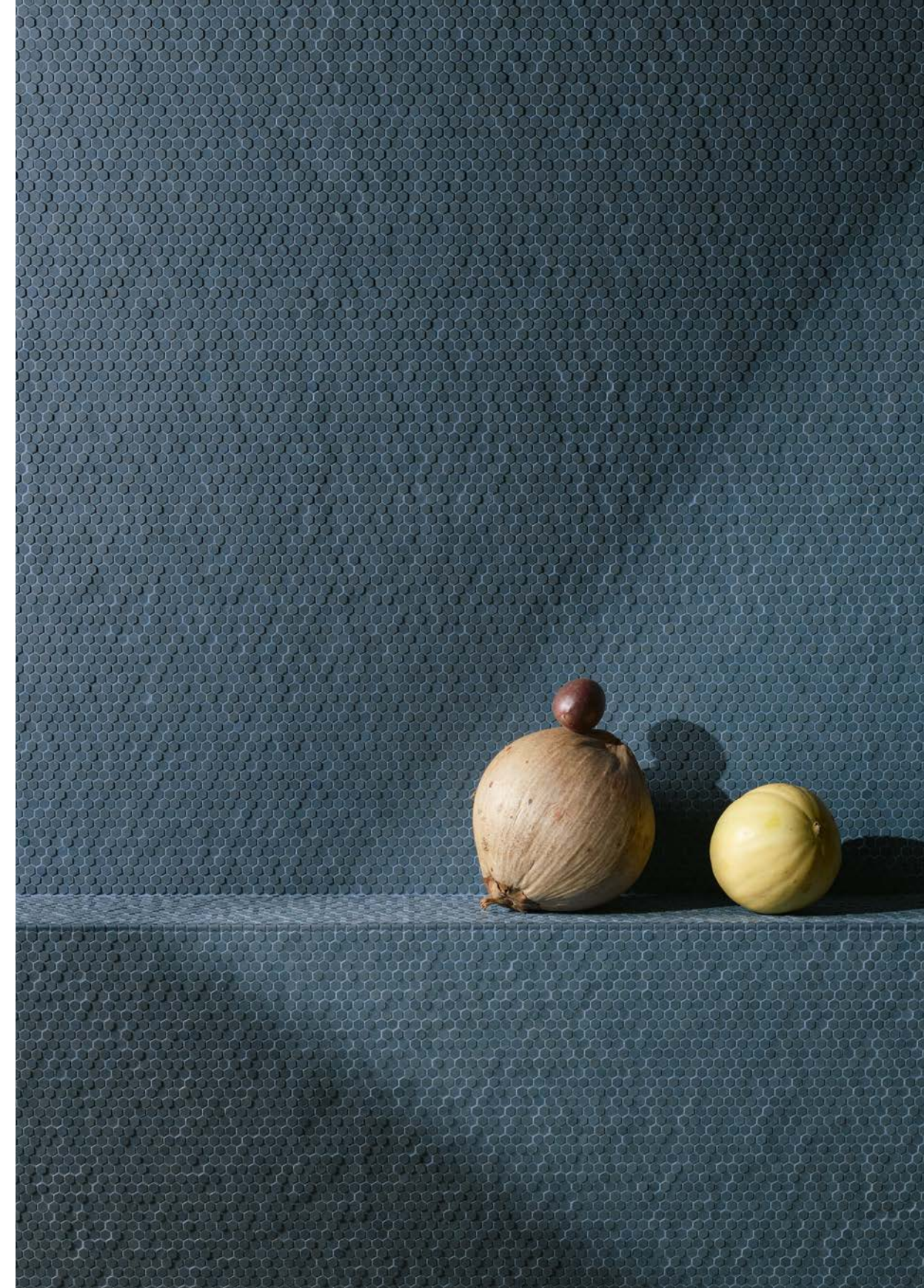

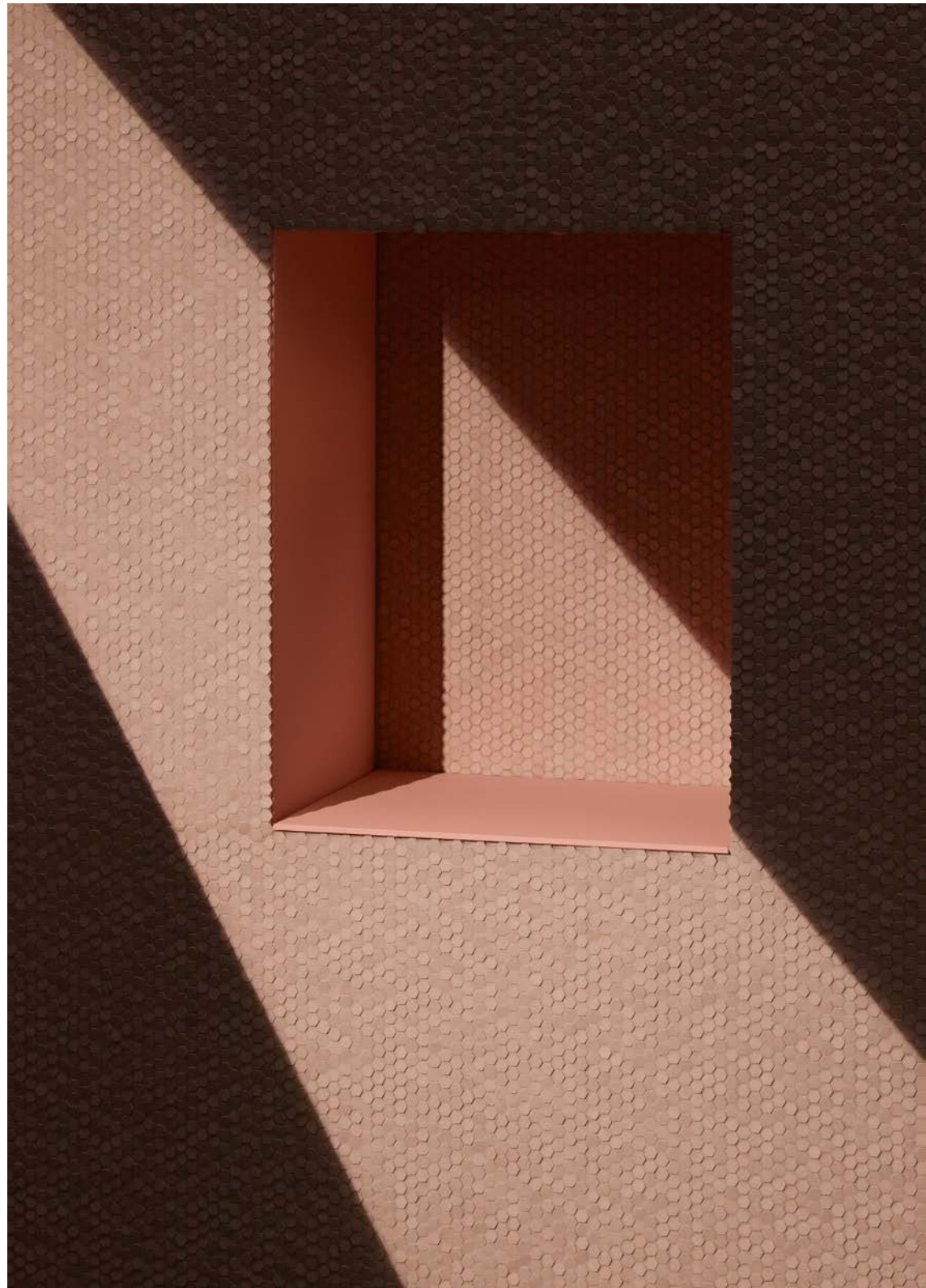

















Phenomenon Glossy





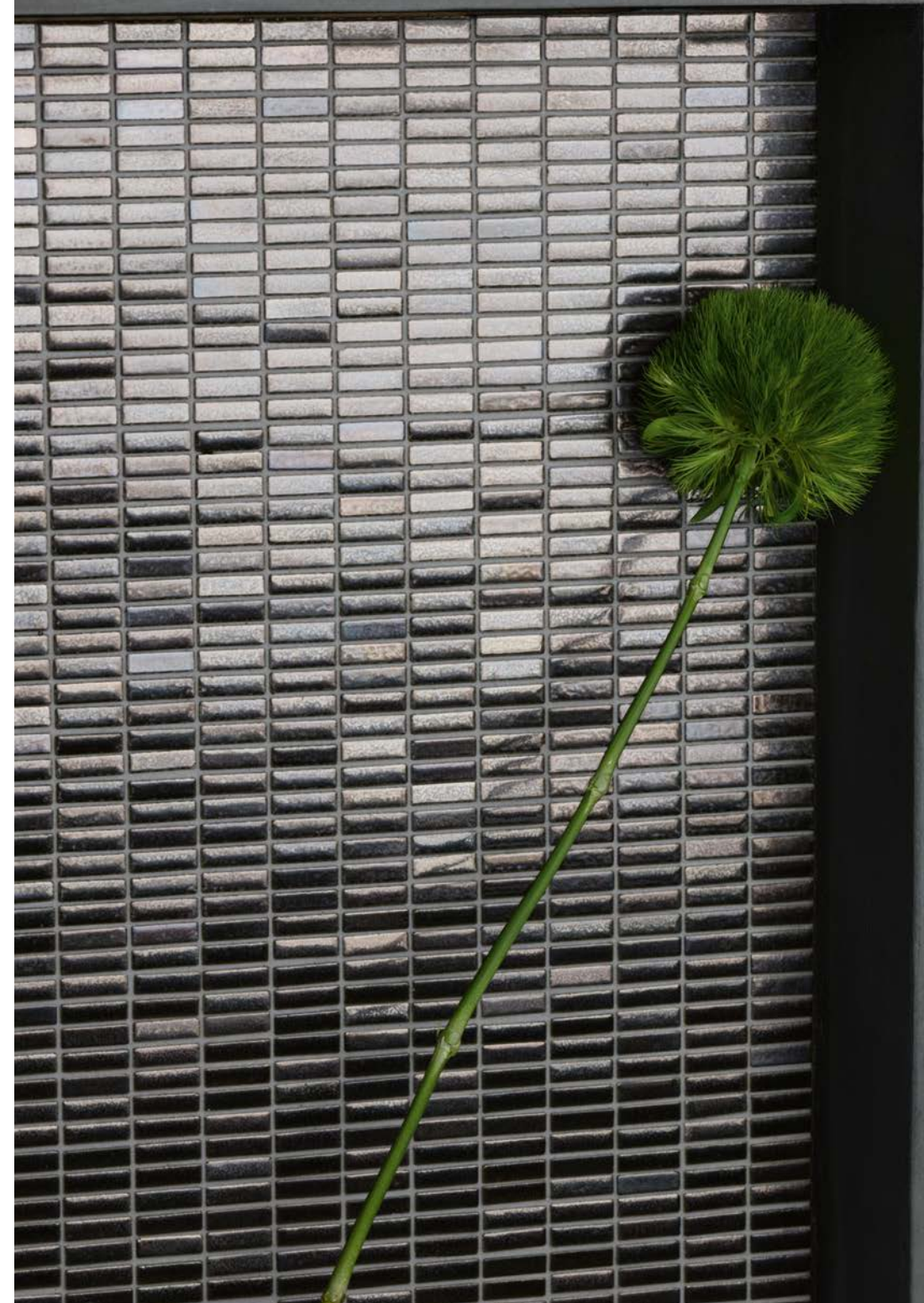

Phenomenon

Technical Features



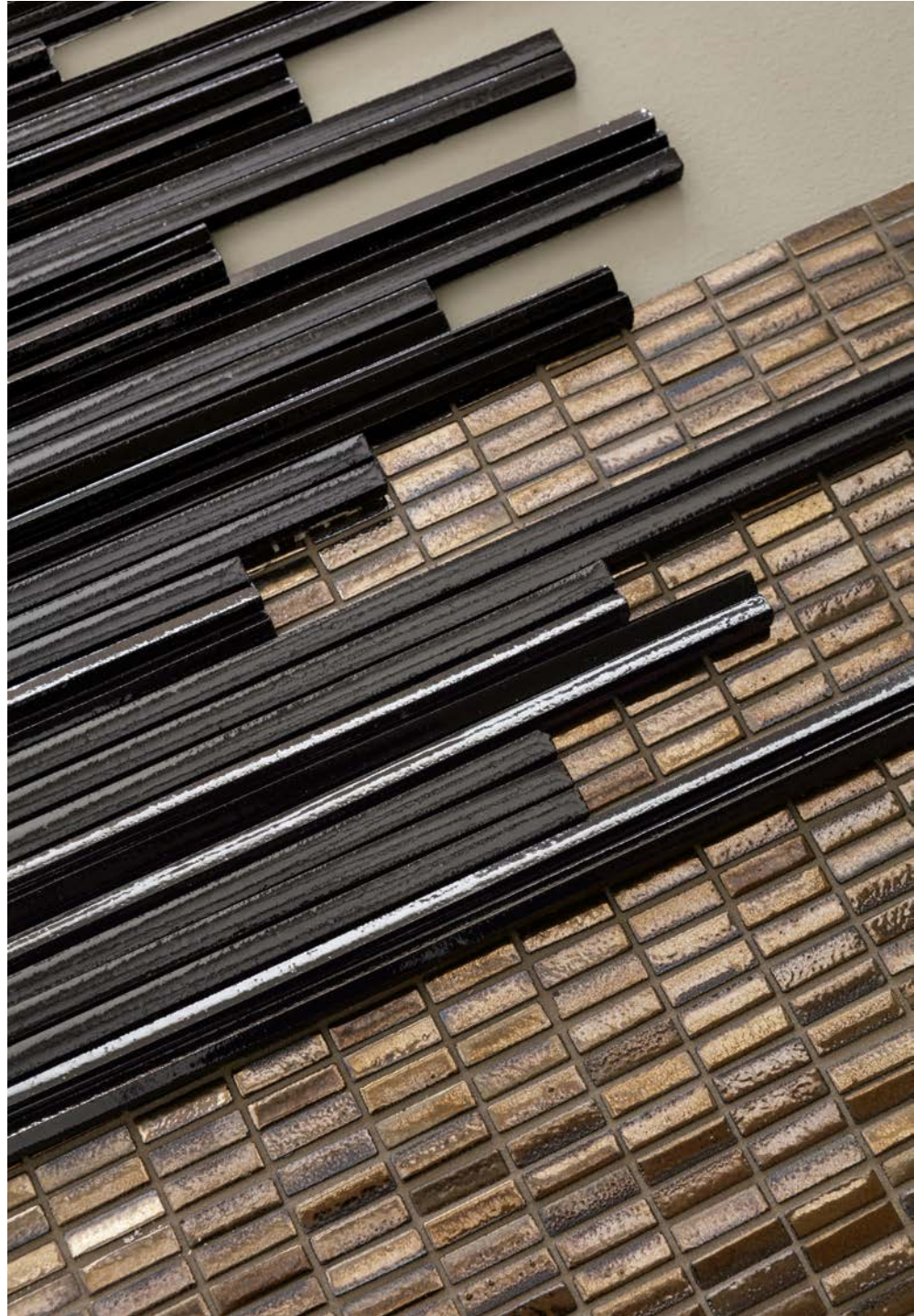
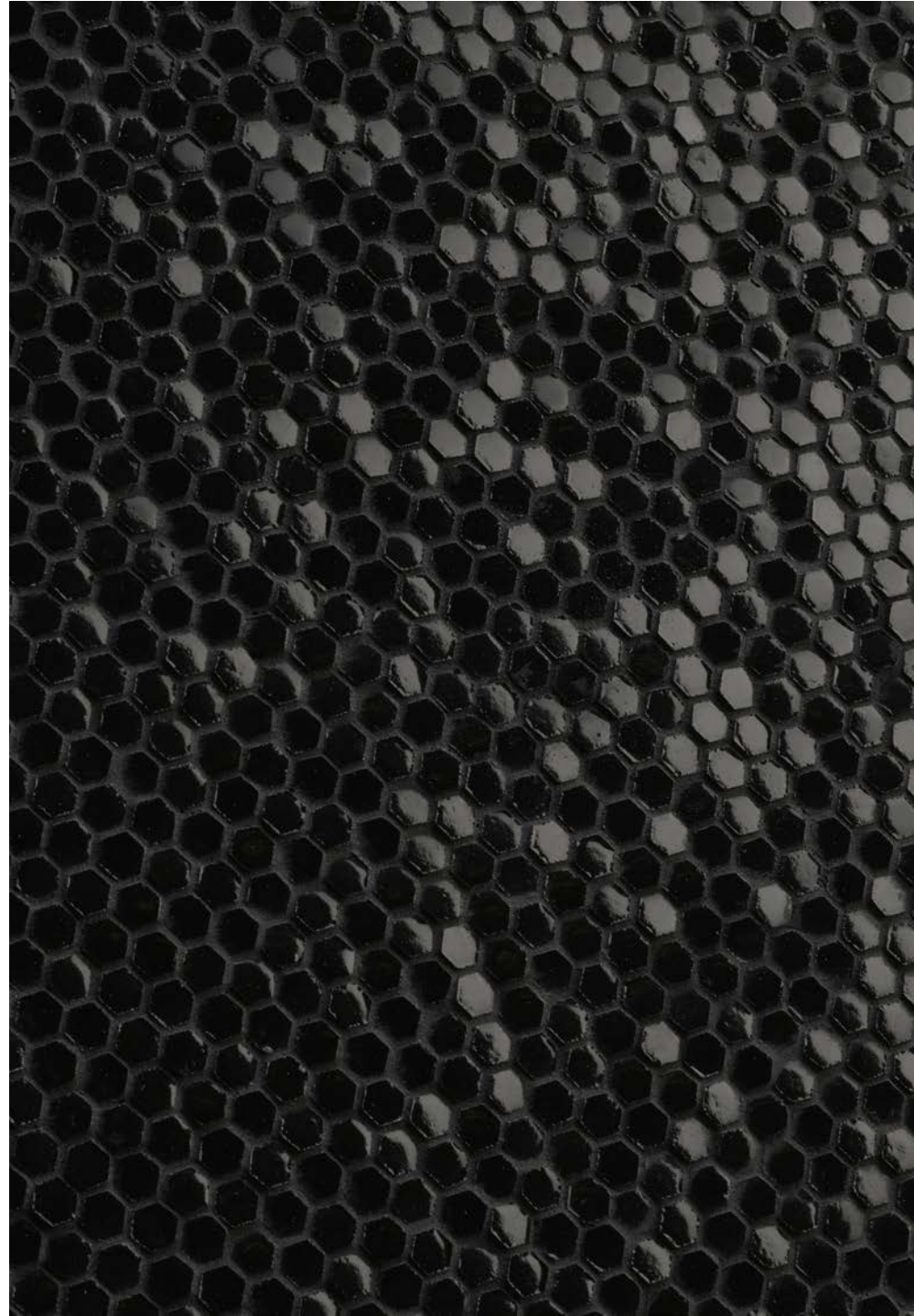
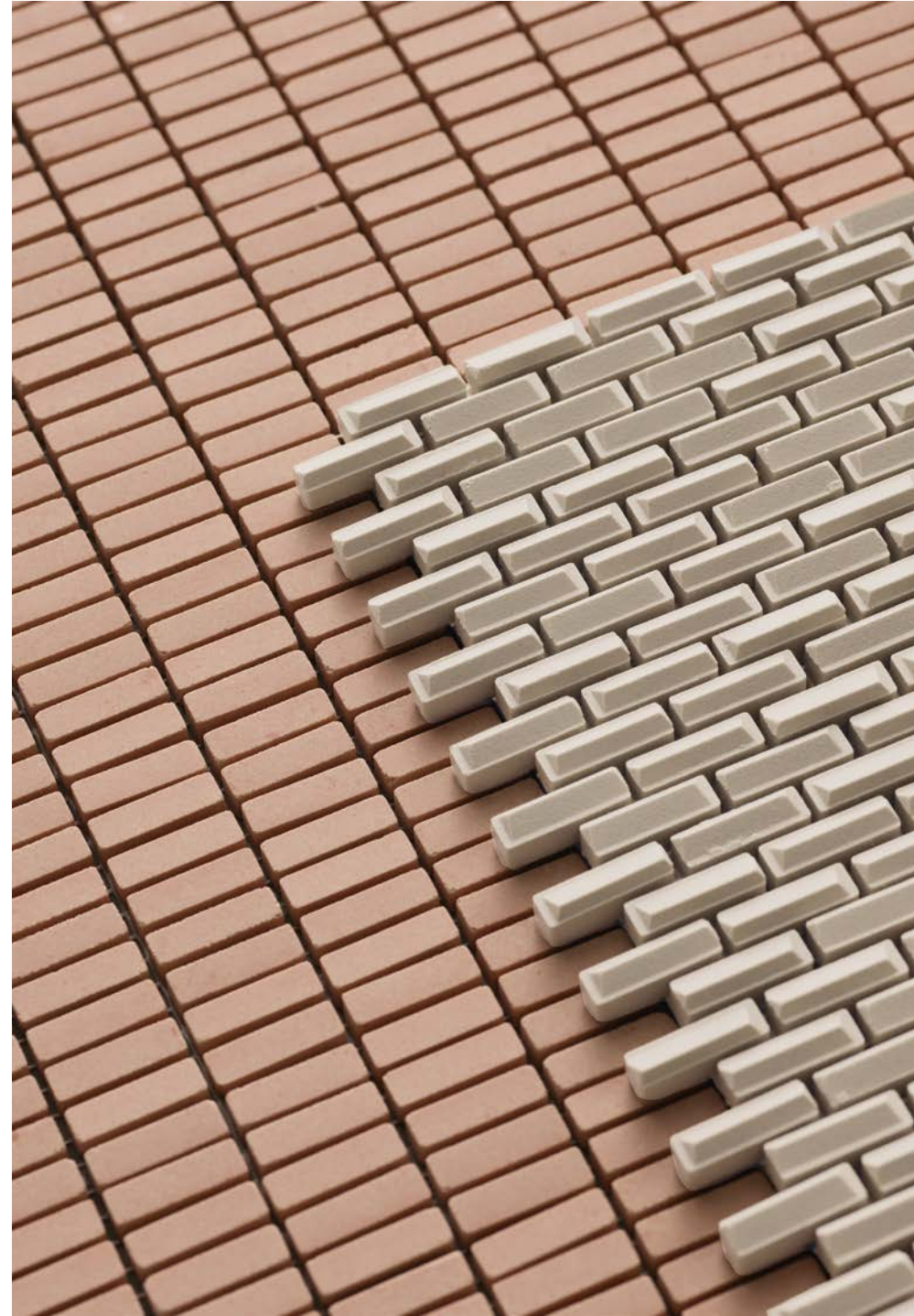
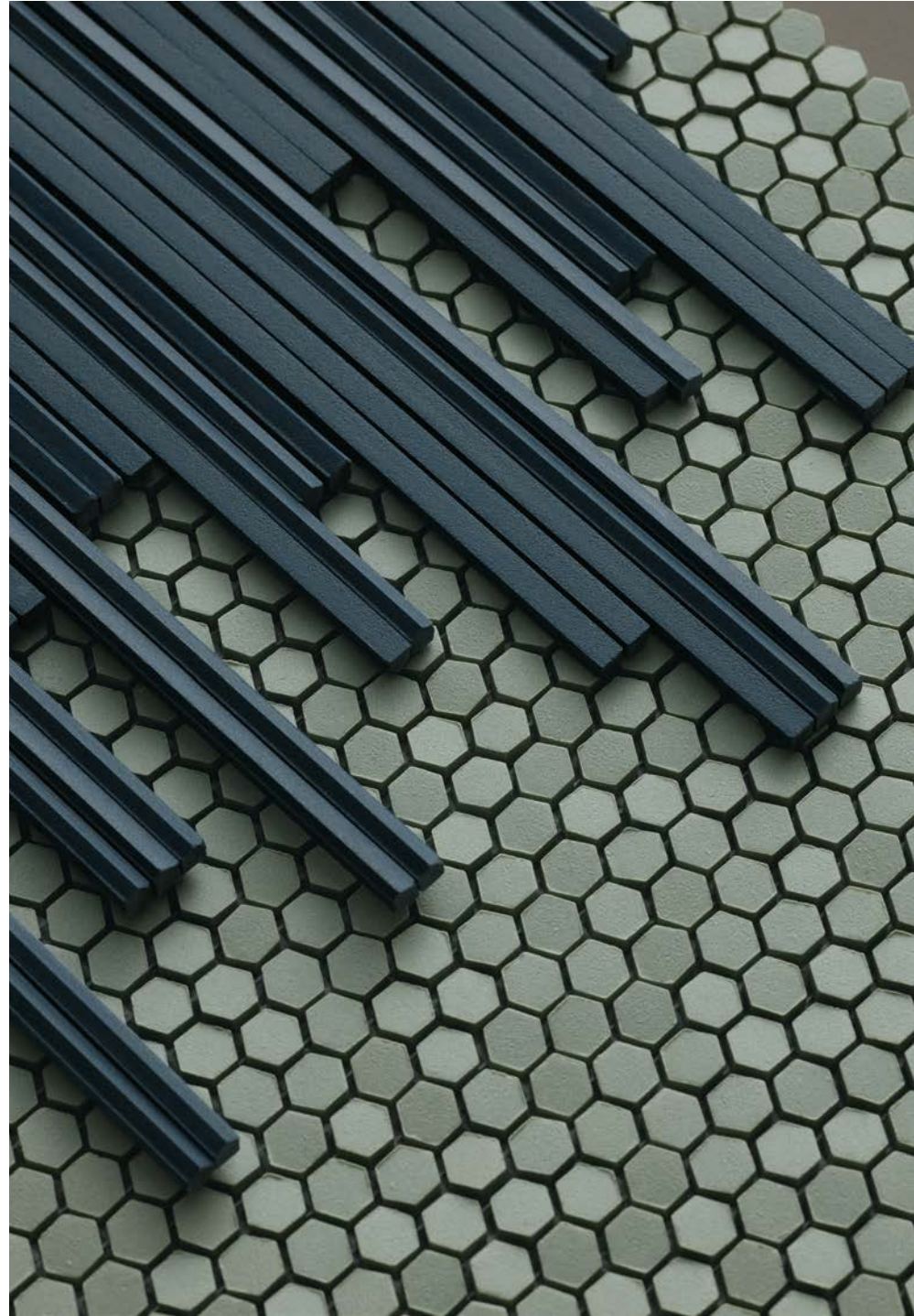

Phenomenon Rain

collection	Phenomenon
design	Tokujiin Yoshioka, 2010 – 2013 – 2022
production	Artisanal
material	Homogeneous unglazed porcelain stoneware straws, obtained by pressing and fixed on net
thickness	RAIN A: min 5 mm - max 7 mm RAIN B: min 5 mm - max 7 mm RAIN C: 5 mm
nominal sizes	RAIN A: net 25-30 cm (net 9 7/8"-12") RAIN B: net 25-30 cm (net 9 7/8"-12") RAIN C: net 25-30 cm (net 9 7/8"-12")
specification	<ul style="list-style-type: none"> - 7 colours: Bianco, Grigio, Fango, Nero, Blu, Verde, Rosa - 3 mosaic card shapes on net - The mosaic is assembled in sheets to give a "handmade look" to the surface. Rain A-B-C, Honeycomb A-B, Rock, Air, Wind, of the series Phenomenon represent the finest of modern-day Italian craftsmanship. - Each mosaic card is individually pressed with a bespoke 100-holes mould, expressly created to achieve a materic and artisanal feeling, then fired through a bespoke, patented, process. - Mutina patented production process and machines (Industrial Patent filed on 02/09/2010 under number MO2010A000247) - The cards are manually assembled accurately by expert hands to build a unique, innovative pattern.
awards	ICFF Editors Award Material 2011, Wallpaper Design Award 2011, Edida 2011, Selected for Adi Design Index 2011, Love Tag Azure Magazine 2012, Red Dot Design Award 2012, Interior Innovation Award 2014, Best of Best 2014
patents	Registered design n° 001912999-0011 – date of registration: 06/09/2011
category	UNI EN 14411 App G (BIA group) UGL

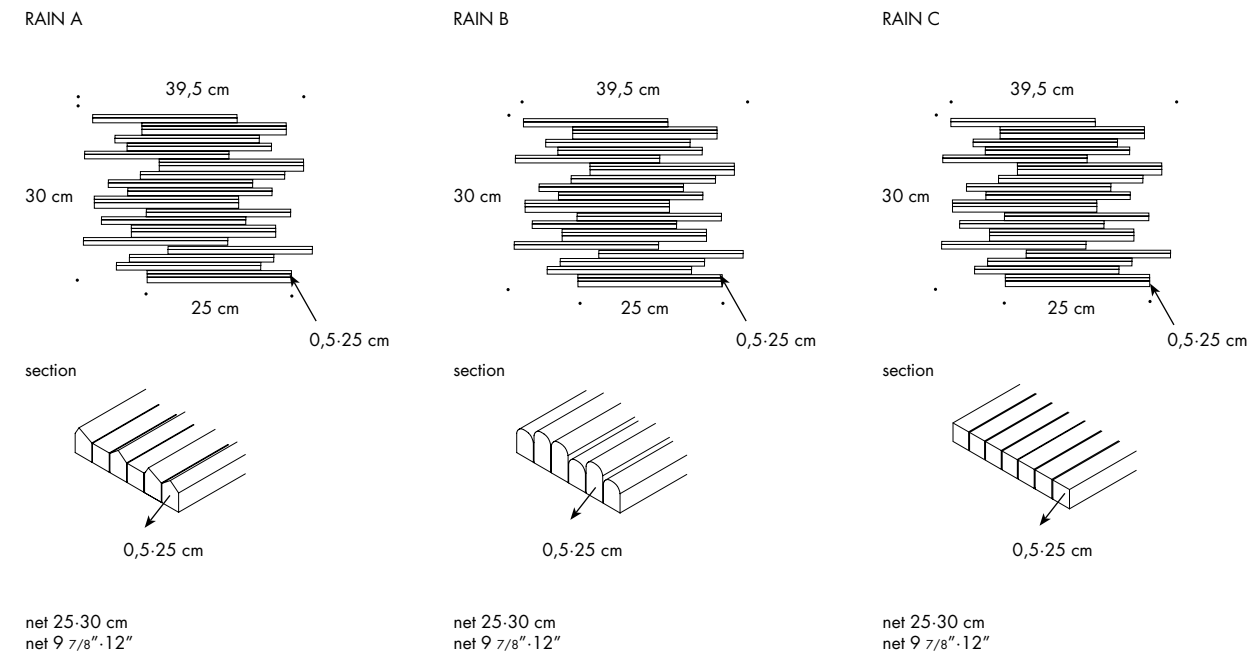

Colors



Mosaics: Honeycomb, Rock, Air, Wind

collection	Phenomenon
design	Tokuji Yoshioka, 2010 - 2013 - 2022
production	Artisanal
material	Homogeneous unglazed porcelain stoneware tesserae, obtained by pressing and fixed on net
thickness	HONEYCOMB A: min 5 mm - max 6 mm HONEYCOMB B: min 6 mm - max 8 mm ROCK: 5 mm AIR: 8 mm WIND: 7 mm
nominal sizes	HONEYCOMB A: net 30-30 cm (net 12"-12") HONEYCOMB B: net 30-30 cm (net 12"-12") ROCK: net 29-29 cm (net 11 13/16"-11 13/16") AIR: net 30-30 cm (net 12"-12") WIND: net 25-25 cm (net 10"-10")
specification	- 7 colours: Bianco, Grigio, Fango, Nero, Blu, Verde, Rosa - 5 mosaic card shapes on net - The mosaic is assembled in sheets to give a "handmade look" to the surface. Rain A-B-C, Honeycomb A-B, Rock, Air, Wind, of the series Phenomenon represent the finest of modern-day Italian craftsmanship. - Each mosaic card is individually pressed with a bespoke 100-holes mould, expressly created to achieve a materic and artisanal feeling, then fired through a bespoke, patented, process. - Mutina patented production process and machines (Industrial Patent filed on 02/09/2010 under number MO2010A000247) - The cards are manually assembled accurately by expert hands to build a unique, innovative pattern.
awards	ICFF Editors Award Material 2011, Wallpaper Design Award 2011, Edida 2011, Selected for Adi Design Index 2011, Love Tag Azure Magazine 2012, Red Dot Design Award 2012, Interior Innovation Award 2014, Best of Best 2014
patents	Registered design n° 001912999-0011 - date of registration: 06/09/2011 Registered design n° 002336909-0001/0004 - date of registration: 31/10/2013
category	UNI EN 14411 App G (BIA group) UGL

HONEYCOMB A

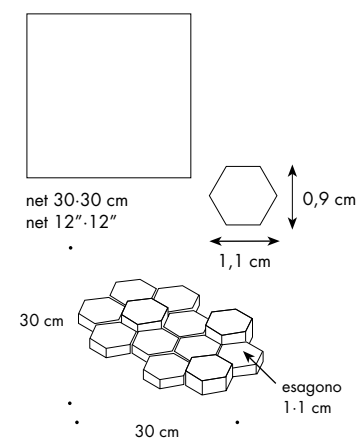

HONEYCOMB B

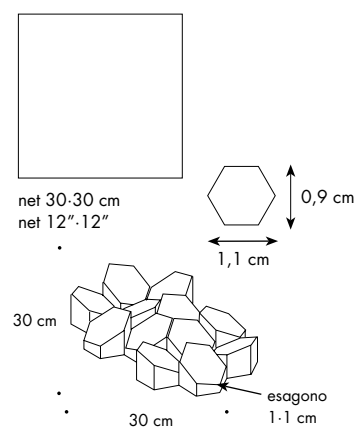

ROCK

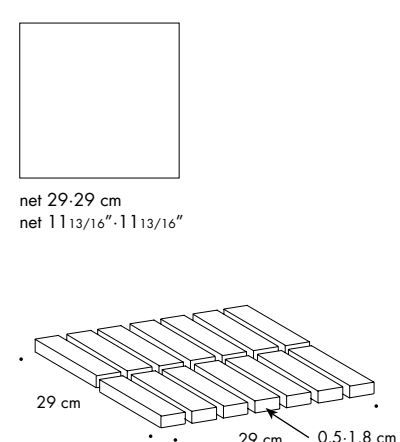

AIR

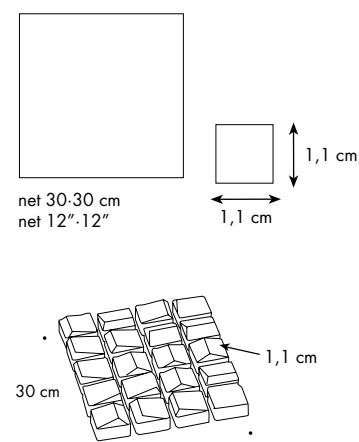

WIND

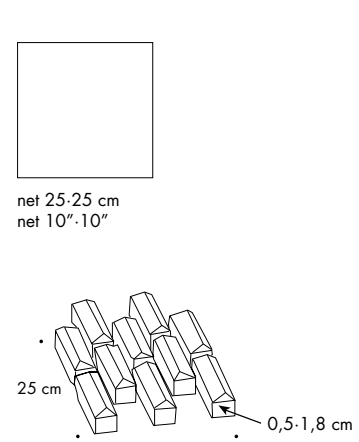

Colors

HONEYCOMB A



Honeycomb A Bianco



Honeycomb A Grigio



Honeycomb A Fango

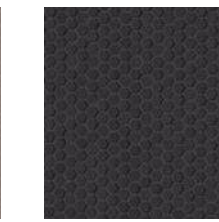

Honeycomb A Nero

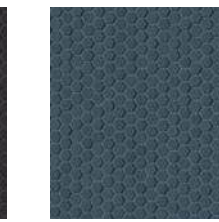

Honeycomb A Blu

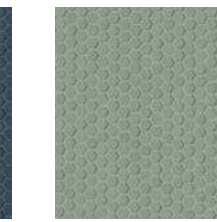

Honeycomb A Verde

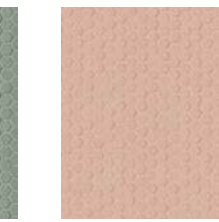

Honeycomb A Rosa

HONEYCOMB B

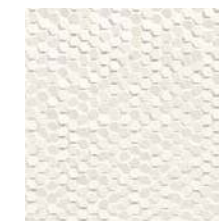

Honeycomb B Bianco

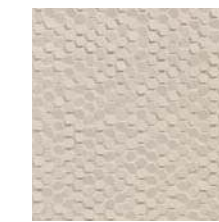

Honeycomb B Grigio



Honeycomb B Fango

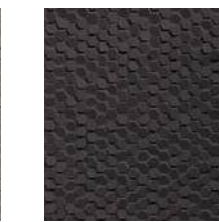

Honeycomb B Nero

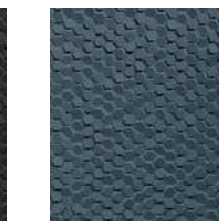

Honeycomb B Blu

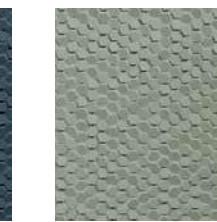

Honeycomb B Verde



Honeycomb B Rosa

ROCK

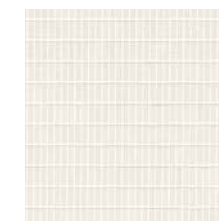

Rock Bianco

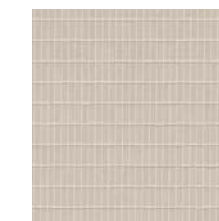

Rock Grigio

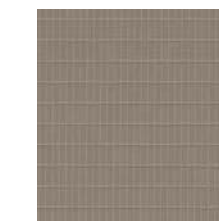

Rock Fango

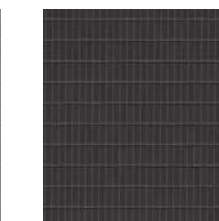

Rock Nero

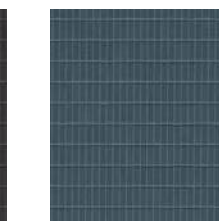

Rock Blu

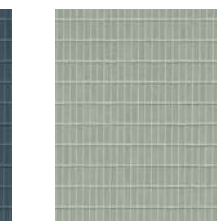

Rock Verde

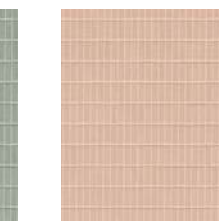

Rock Rosa

AIR



Air Bianco



Air Grigio



Air Fango

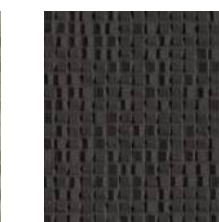

Air Nero

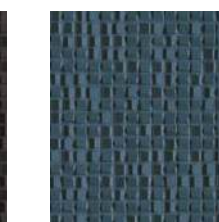

Air Blu

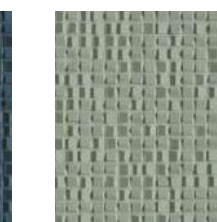

Air Verde

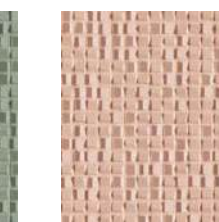

Air Rosa

WIND



Wind Bianco



Wind Grigio

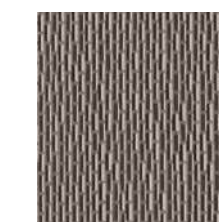

Wind Fango

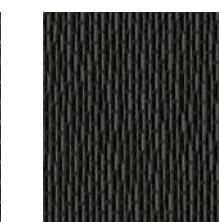

Wind Nero

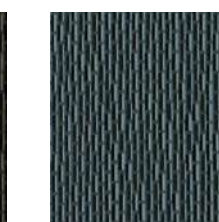

Wind Blu

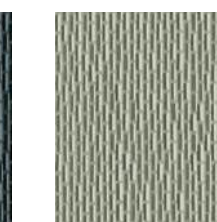

Wind Verde



Wind Rosa

Phenomenon Glossy: Rain A, Honeycomb B, Rock

collection	Phenomenon Glossy
design	Tokuji Yoshioka, 2022
production	Artisanal
material	Homogeneous glazed porcelain stoneware tesserae and straws, obtained by pressing and fixed on net
thickness	RAIN A: MIN 5 mm - MAX 7 mm HONEYCOMB B: min 6 mm - max 8 mm ROCK: 5 mm
nominal sizes	RAIN A: net 25-30 cm (net 9 7/8"-12") HONEYCOMB A: net 30-30 cm (net 12"-12") ROCK: net 29-29 cm (net 11 13/16"-11 13/16")
specification	<ul style="list-style-type: none"> - 4 colours: Bianco Glossy, Nero Glossy, Oro, Argento - 3 mosaic card shapes on net - The mosaic is assembled in sheets to give a "handmade look" to the surface. Rain A, Honeycomb B, Rock, of the series Phenomenon represent the finest of modern-day Italian craftsmanship. - Each mosaic card is individually pressed with a bespoke 100-holes mould, expressly created to achieve a materic and artisanal feeling, then fired through a bespoke, patented, process. - Mutina patented production process and machines (Industrial Patent filed on 02/09/2010 under number MO2010A000247) - The cards are manually assembled accurately by expert hands to build a unique, innovative pattern.
patent	Registered design n° 001912999-0011 - date of registration: 06/09/2011
category	UNI EN 14411 App G (BIA group) GL

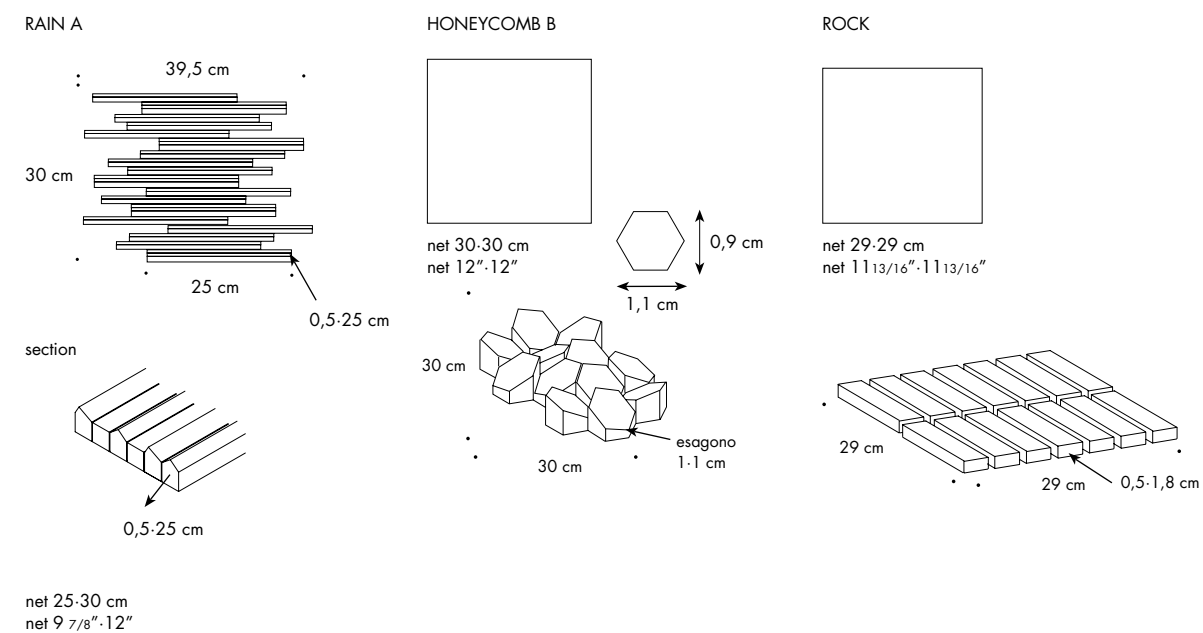

Colors

RAIN A GLOSSY



Rain A Bianco Glossy



Rain A Nero Glossy



Rain A Oro

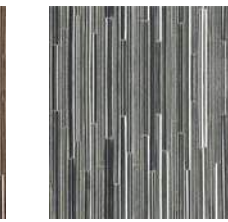

Rain A Argento

HONEYCOMB B GLOSSY



Honeycomb B Bianco Glossy



Honeycomb B Nero Glossy



Honeycomb B Oro

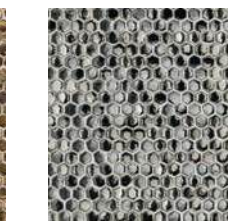

Honeycomb B Argento

ROCK GLOSSY



Rock Bianco Glossy



Rock Nero Glossy

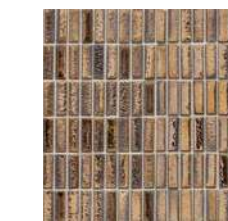

Rock Oro

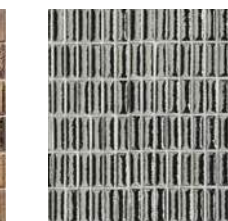

Rock Argento

Special Pieces

RACCORDO ESTERNO
HONEYCOMB A + B

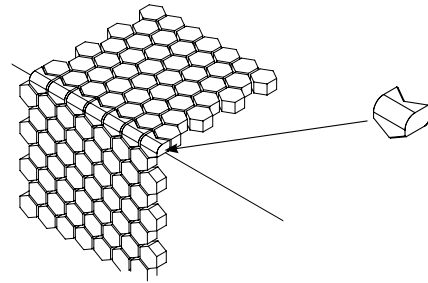
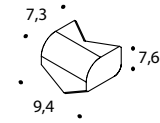

Laying and maintenance tips (Phenomenon)

use	Floor (ROCK, HONEYCOMB A), wall (ROCK, HONEYCOMB A, WIND, AIR, HONEYCOMB B, RAIN A-B-C) – indoor, outdoor.
installation	Lay on perfectly flat, dry walls.
recommended adhesive	NON-RAPID-DRYING adhesive for porcelain stoneware to make it easier to fix the sheets.
recommended joints	2mm joints.
recommended fillers	CEMENT-BASED GROUT: (all mosaics). Grout 0.5 m ² at a time and wash thoroughly with clean water. Remove all traces of grout carefully before it dries completely. EPOXY GROUT: (rock, honey A only). Grout 0.5 m ² at a time and wash thoroughly with clean water. Remove all traces of grout carefully before it dries completely.
cleaning at the end of installation	CEMENT-BASED GROUT: Buffered acid (e.g. DETERDEK PRO by FILA, or similar). Wet the floor with water, dilute the product 1:5 with water and pour it on the floor. Wait for 2 or 3 minutes then use a white scotch brite pad and rinse well with clean water. EPOXY GROUT: Alkaline detergent (e.g. FILA CR10 by FILA). FILA CR10: apply pure, wait for 30 minutes then use a green scotch brite pad. SILICONE: Solvent for silicone (e.g. FILA ZERO SIL.). Pour it straight onto the stain, wait for 20 minutes and remove the mark using scotch brite. PAINT: Can usually be removed using water, but if resin-based paints or particular enamels have been used, it is best to ask the manufacturer which solvent is most suitable. RUST: stain remover es. FILA NO RUST. Apply the product onto the stain, leave for 15 minutes, remove the residue and rinse thoroughly.
general cleaning (installed tiles)	You are recommended to use ordinary neutral detergent diluted in water. Avoid using acid or alkaline products, waxes and/or impregnants. During ordinary cleaning it is recommended to use extremely abrasive items (such as scourers and iron or steel sponges) as little as possible. This recommendation must be adhered to rigorously in the case of tiles with a glossy surface finishing as they are more susceptible to the risk of scuffs, scratches and loss of shine, etc. In the event of heavy dirt or particularly textured surfaces, use an alkaline detergent and rinse after washing. For large surfaces, the use of a floor washing machine is recommended. During every-day cleaning procedures, it is necessary to remember that certain types of dirt (dust, sand) increase the abrasive effect of foot-traffic. Therefore we recommend that you avoid bringing in this type of dirt, which comes in from the outside, by placing a door-mat at the entrance.
calibers (real size)	–

Laying and maintenance tips (Phenomenon Glossy)

use	Walls, indoors.
installation	Lay on perfectly flat, dry walls.
recommended adhesive	NON-RAPID-DRYING adhesive for porcelain stoneware to make it easier to fix the sheets.
recommended joints	Place the sheets with the same joint as within the sheet.
recommended fillers	CEMENT-BASED GROUT: (all mosaics). Grout 0.5 m ² at a time and wash thoroughly with clean water. Remove all traces of grout carefully before it dries completely. EPOXY GROUT: (rock, honey A only). Grout 0.5 m ² at a time and wash thoroughly with clean water. Remove all traces of grout carefully before it dries completely.
advice for cleaning at the end of the work and for routine cleaning	We advise using neutral detergent diluted in water. Do not use acid or alkaline products, waxes and/or stains. Where possible, for routine cleaning avoid the use of more abrasive products (scouring pads, metal sponges). It is strongly recommended not to use these products on tiles with glossy surface finish, as these are more susceptible to scratching, and may lose their shine, etc.
calibers (real size)	–

Technical features

STANDARD	FEATURES	VALUE REQUIRED	PHENOMENON
ISO 10545/3	water absorption	< 0,5%	0,1%
ISO 10545/9	resistance to thermal shock	no visible alteration	resistant
ISO 10545/12	frost resistance	no visible alteration	resistant
ISO 10545/13	resistance to chemical attacks	minimum B	A B glossy finishing
ISO 10545/14	stains resistance	minimum 3	5
VOC Emission			available upon request
Declaration of Contents			available upon request
EPD			available upon request
SDS			available upon request
BPD3			available upon request
HPD			available upon request

Packing

SIZE	PCS-SQM	PCS-BOX	SQM-BOX	BOX-PAL	KG-BOX	KG-PAL	SQM-PAL
rain A net 25-30 cm	13,34	5	0,375	60	4,55	273,00	22,50
rain B net 25-30 cm	13,34	5	0,375	60	4,55	273,00	22,50
rain C net 25-30 cm	13,34	5	0,375	60	4,55	273,00	22,50
honeycomb A net 30-30 cm	11,11	8	0,72	42	7,50	315,00	30,24
honeycomb B net 30-30 cm	11,11	8	0,72	42	8,55	315,00	30,24
rock net 29-29 cm	11,90	11	0,92	42	8,10	340,00	38,64
air net 30-30 cm	11,11	11	0,99	42	10,10	424,00	41,58
wind net 25-25 cm	16,00	8	0,50	60	5,60	336,00	30,00
raccordo esterno honeycomb A+B 9,4-7,6-7,3 cm	86 ml	26	0,30	-	0,05	-	-

Tokujin Yoshioka

Tokujin Yoshioka, artista e designer giapponese, è entrato a far parte del team Mutina nel 2010. Ha disegnato le collezioni Phenomenon, Botanica e Phenomenon Plate.

Tokujin Yoshioka nasce nel 1976 in Giappone, dove si forma con Shiro Kuramata e Issey Miyake, per poi aprire il proprio studio nel 2000. Ha collaborato con aziende giapponesi e internazionali come Hermès, Toyota, BMW, Swarovski, Driade, Moroso e Kartell, tra gli altri. La cifra caratteristica del suo approccio creativo è costituita dalla poesia e dalla leggerezza onirica delle sue opere, che nascono da un’attenta e sofisticata ricerca su materiali semplici abbinata alla sperimentazione tecnologica. La “Sakura

Torch” per i Giochi Olimpici di Tokyo del 2020, la panca in vetro esposta al Musée d’Orsay chiamata “Water Block”, l’architettura con prismi di cristallo “Rainbow Church”, la sedia in cristallo naturale “VENUS” e la casa da tè “KOU-AN” sono alcuni dei tanti capolavori realizzati. Alcuni dei suoi pezzi sono esposti al MoMA, al Musée National d’Art Moderne e al Victoria and Albert Museum. Ha vinto diversi premi, tra cui: Design Miami, Designer of the Year 2007, Wallpaper Design Awards 2008 e Elle Decoration International Design Award, Designer of the Year 2009. Grazie alla collezione Phenomenon, disegnata per Mutina, nel 2011 ha ricevuto il Wallpaper Design Award e l’Elle Decoration Design Award.

Japanese artist and designer Tokujin Yoshioka joined the Mutina team in 2010. He designed the Phenomenon, Botanica and Phenomenon Plate collections.

Tokujin Yoshioka was born in 1967 in Japan, where he trained with Shiro Kuramata and Issey Miyake, and opened his studio in 2000. He collaborated with Japanese and international brands, such as Hermès, Toyota, BMW, Swarovski, Driade, Moroso and Kartell, among others. The signature feature of his creative approach is the poetic and light, dreamlike quality of his work, which stems from attentive and sophisticated selection of simple materials combined with technological experimentation. The “Sakura Torch” for the Tokyo 2020 Olympic Games, the

glass bench exhibited at Musée d’Orsay called “Water Block,” the crystal prism architecture “Rainbow Church,” the natural crystal chair “VENUS,” and the glass teahouse “KOU-AN” are some of the many masterpieces announced. Some of his works are exhibited at MoMA, at Musée National d’Art Moderne and the Victoria and Albert Museum. His awards include Design Miami, Designer of the Year 2007, Wallpaper Design Awards 2008 and Elle Decoration International Design Award, Designer of the Year 2009. In 2011 he received the Wallpaper Design Award and the Elle Decoration Design Award for his Phenomenon collection designed for Mutina.

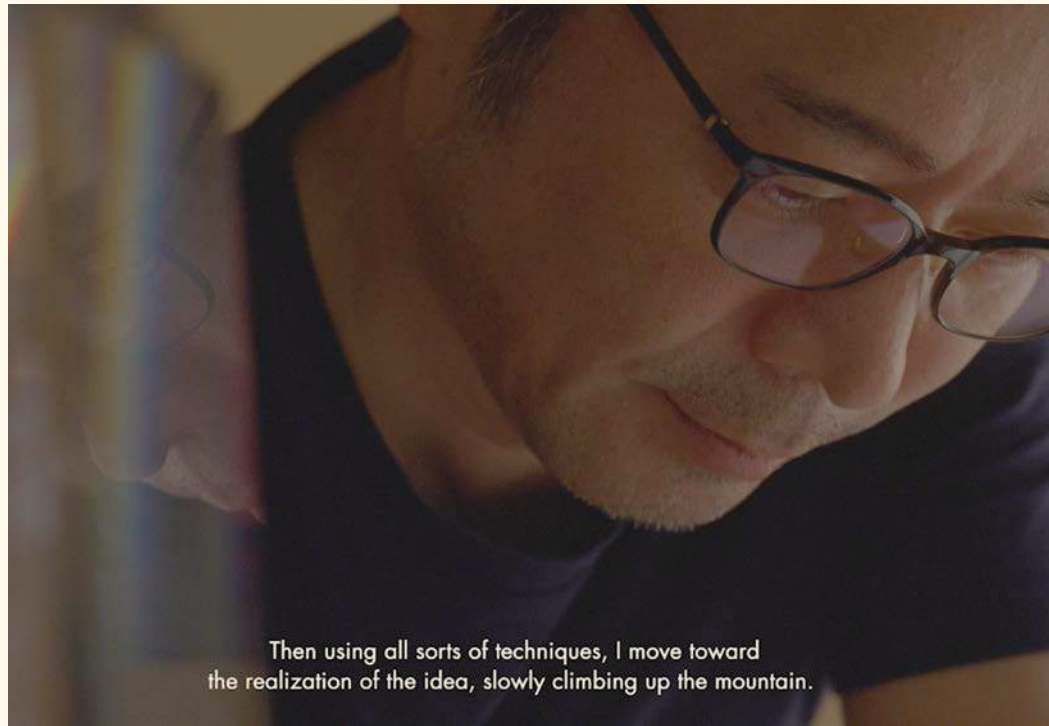

Then using all sorts of techniques, I move toward the realization of the idea, slowly climbing up the mountain.



There is no kind of beauty that surpasses nature. Nature never shows you the same thing twice.

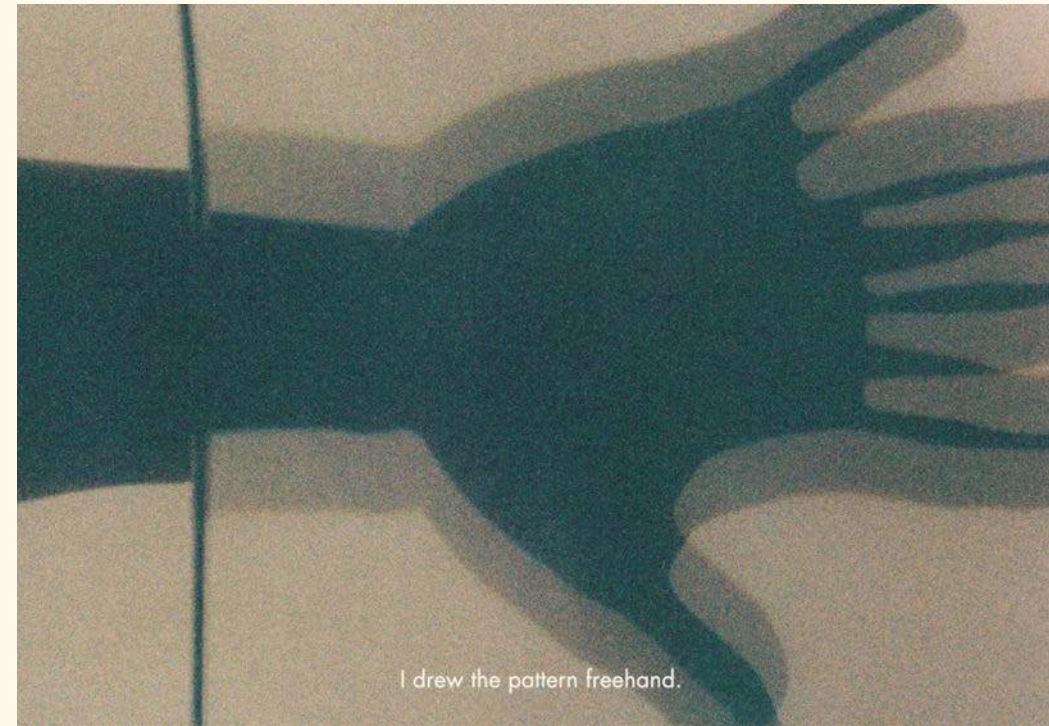

I drew the pattern freehand.



In the end, it's something that can effect people's emotions. That's the kind of thing I want to give form to.

CREDITS

Art direction: Alla Carta Studio
Graphic design: Matteo Pastorio
Text: Mutina
Photography: Gerhardt Kellermann
Set design: Sonia Pravato
Video frames by Xavier Tera
Printed and bound in Italy. September 2022.

Special thanks to
Enrico Donadello Ceramiche
Paola C

All the rights are reserved.
Not any part of this work can be reproduced
in any way without the preventive written
authorization by Mutina. All work is
copyrighted © to their respective owners.

To discover more about Mutina
collections visit mutina.it

Ceramiche Mutina Spa
Via del Crociale 25
41042 Fiorano MO, Italia
T +39 0536812800
F +39 0536812808
info@mutina.it
www.mutina.it

© Mutina 2022

